

TECHNICAL DATA SHEET

TECHNICAL DATA

Inlet connection : DN 550
Outlet connection : DN 450
Lubrication : Oil
Impeller diameter (min-max) : 375-420 mm
Impeller tip speed : 85-110 m/s
Drive : Direct drive or Gear box
Shaft end : 80
Driving shaft seals : Simmering ring
Impeller shaft seals : Two-sided labyrinth with leakage reception
Base frame installation : Shock absorbing pads
Noise level : Below 85dB(A)

MATERIALS OF CONSTRUCTION

Casing : Cast iron EN-GJL-250
Impeller : Aluminium En-AW-7022 or EN-AW-7075
Shaft : Carbon steel 42 Cr Mo4
Helical gear : Carbon steel 34 CrNiMo6
Bearings : Sleeve Bearings

CC380

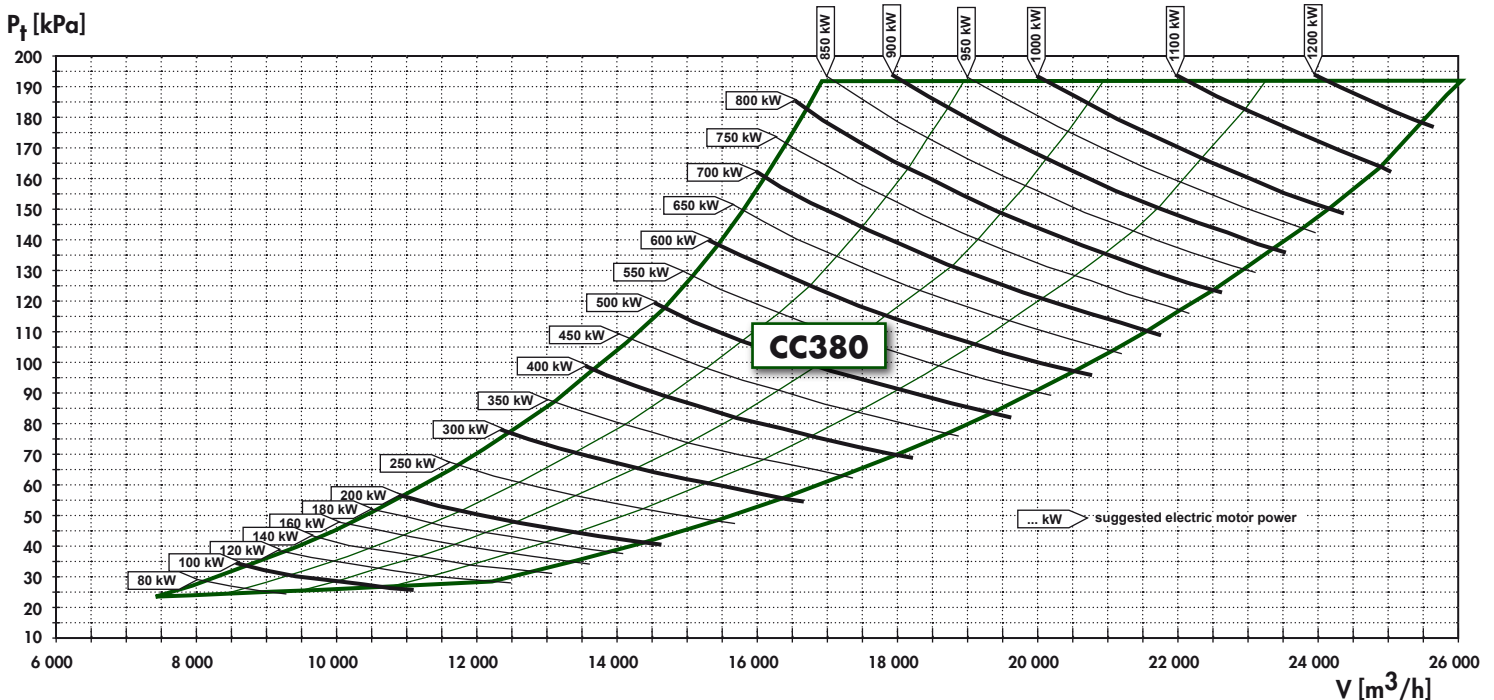
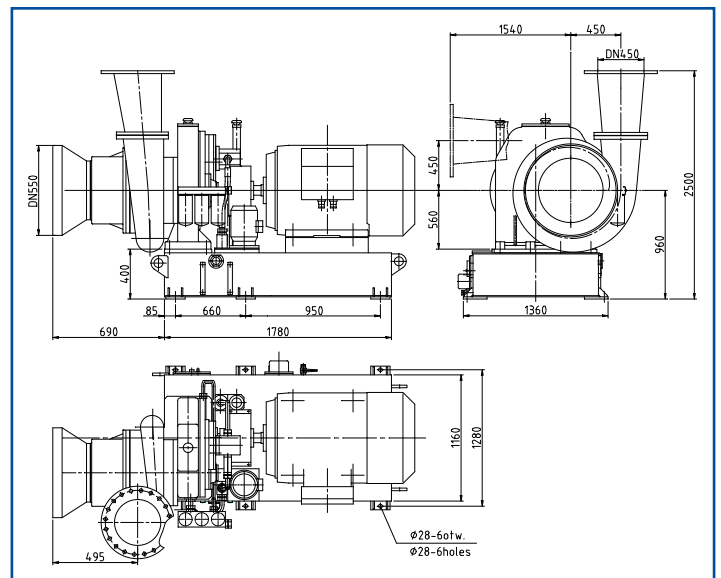

Values, dimensions and reference in this brochure are approximate and intended as a guide only, not for construction and are subject to change without notice.

HCP CONTINENTAL TURBO . HCP CONTINENTAL TURBO . HCP CONTINENTAL TURBO .

