

# TECHNICAL DATA SHEET

## TECHNICAL DATA

**Inlet connection :** DN 500  
**Outlet connection :** DN 400  
**Lubrication :** Oil  
**Impeller diameter (min-max) :** 620-690 mm  
**Impeller tip speed :** 80-90 m/s  
**Drive :** Direct drive or Gear box  
**Shaft end :** 80  
**Driving shaft seals :** Simmering ring  
**Impeller shaft seals :** Two-sided labyrinth with leakage reception  
**Base frame installation :** Shock absorbing pads  
**Noise level :** Below 92dB(A)

## MATERIALS OF CONSTRUCTION

**Casing :** Cast iron EN-GJL-250  
**Impeller :** Aluminium En-AW-7022 or EN-AW-7075  
**Shaft :** Carbon steel 42 Cr Mo4  
**Helical gear :** Carbon steel 34 CrNiMo6  
**Bearings :** Sleeve Bearings

## CC650

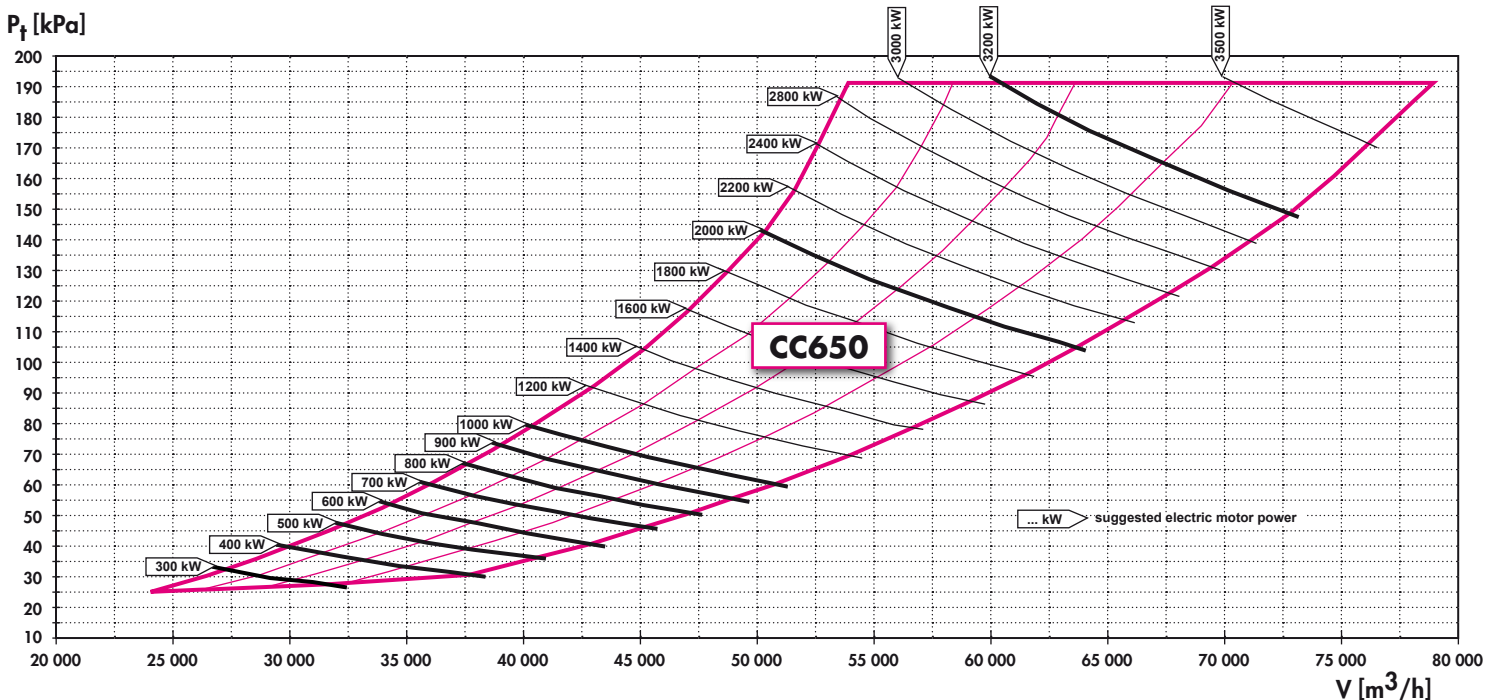
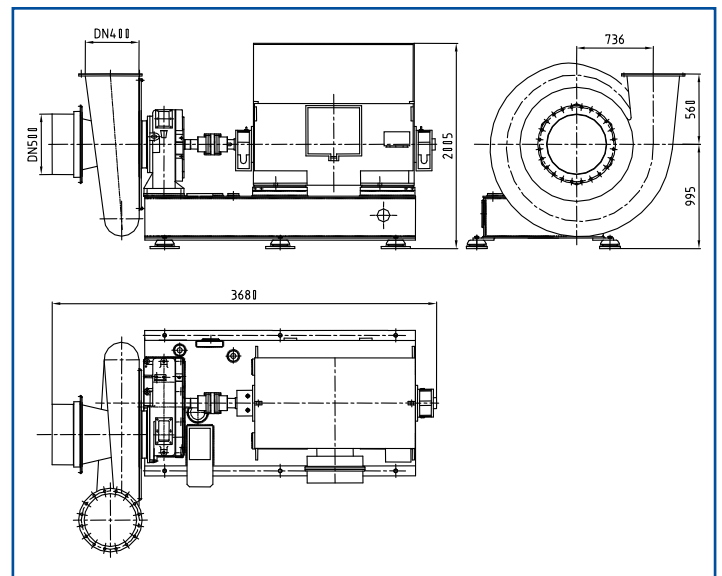

Values, dimensions and reference in this brochure are approximate and intended as a guide only, not for construction and are subject to change without notice.

HCP CONTINENTAL TURBO . HCP CONTINENTAL TURBO . HCP CONTINENTAL TURBO .

